



BAV23 Series Silicon Epitaxial Planar Switching Diode

Features

- High voltage
- Small package
- Small capacitance

SOT-23

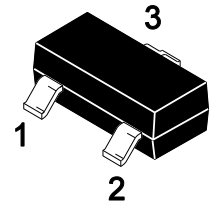

Equivalent Circuit

BAV23

3.Cathode

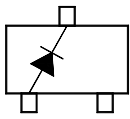

1.Anode 2.NC

BAV23SE

3.Cathode1、Anode2

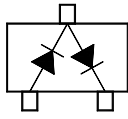

1.Anode1 2.Cathode2

BAV23CC

3.Cathode1、Cathode2

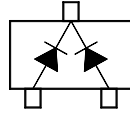

1.Anode1 2.Anode2

BAV23CA

3.Anode1、Anode2

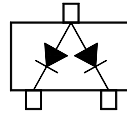

1.Cathode1 2.Cathode2

Marking Code :

BAV23 : JS

BAV23SE : PY

BAV23CC : PZ

BAV23CA : RA

Absolute Maximum Ratings ($T_A=25^\circ\text{C}$)

Parameter	Symbol	Value	Unit
Maximum Repetitive Reverse Voltage	V_{RRM}	250	V
Reverse Voltage	V_R	200	V
Average Rectified Forward Current	$I_{F(AV)}$	400	mA
Repetitive Peak Forward Current	I_{FRM}	625	mA
Non-repetitive Peak Forward Surge Current	I_{FSM}	at t =10 ms 1.7	A
		at t =100 μs 3	
		at t =1 μs 9	
Power Dissipation	P_D	350	mW
Thermal Resistance Junction to Ambient	$R_{\theta JA}$	357	$^\circ\text{C}/\text{W}$
Junction Temperature	T_J	150	$^\circ\text{C}$
Storage Temperature Range	T_{STG}	-65 to +150	$^\circ\text{C}$



BAV23 Series

Silicon Epitaxial Planar Switching Diode

Electrical Characteristics ($T_A=25^\circ\text{C}$)

Parameter	Symbol	Min.	Max.	Unit
Forward Voltage at $I_F = 100\text{ mA}$ at $I_F = 200\text{ mA}$	V_F	-- --	1 1.25	V
Reverse Breakdown Voltage at $I_R = 100\text{ }\mu\text{A}$	$V_{(BR)R}$	250	--	V
Reverse Current at $V_R = 200\text{ V}$, at $T_J = 25\text{ }^\circ\text{C}$ at $V_R = 200\text{ V}$, at $T_J = 150\text{ }^\circ\text{C}$	I_R	-- --	0.1 100	μA
Typical Junction Capacitance at $V_R = 0\text{ V}$, $f = 1\text{ MHz}$	C_j	--	5	pF
Maximum Reverse Recovery Time at $I_F = I_R = 30\text{ mA}$, $I_{rr} = 0.1 \times I_R$, $R_L = 100\text{ }\Omega$	T_{rr}	--	50	nS



BAV23 Series Silicon Epitaxial Planar Switching Diode

Typical Characteristic Curves

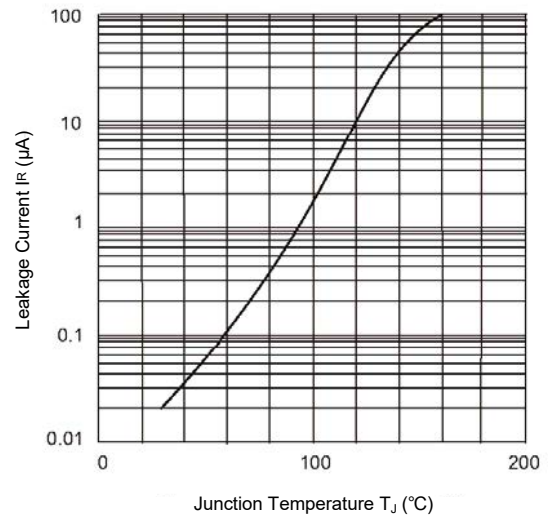
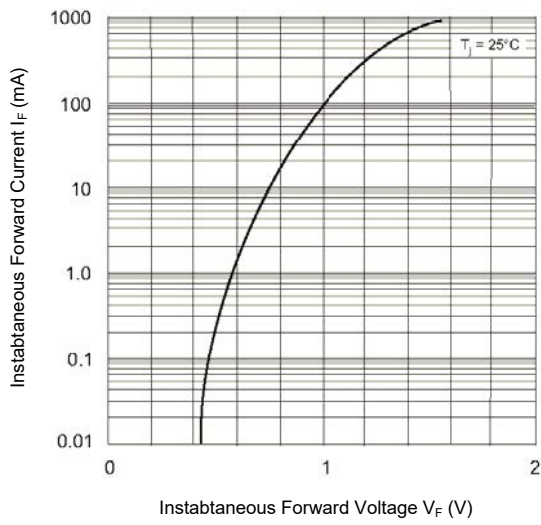



BAV23 Series Silicon Epitaxial Planar Switching Diode

Package Outline

SOT-23

Dimensions in mm

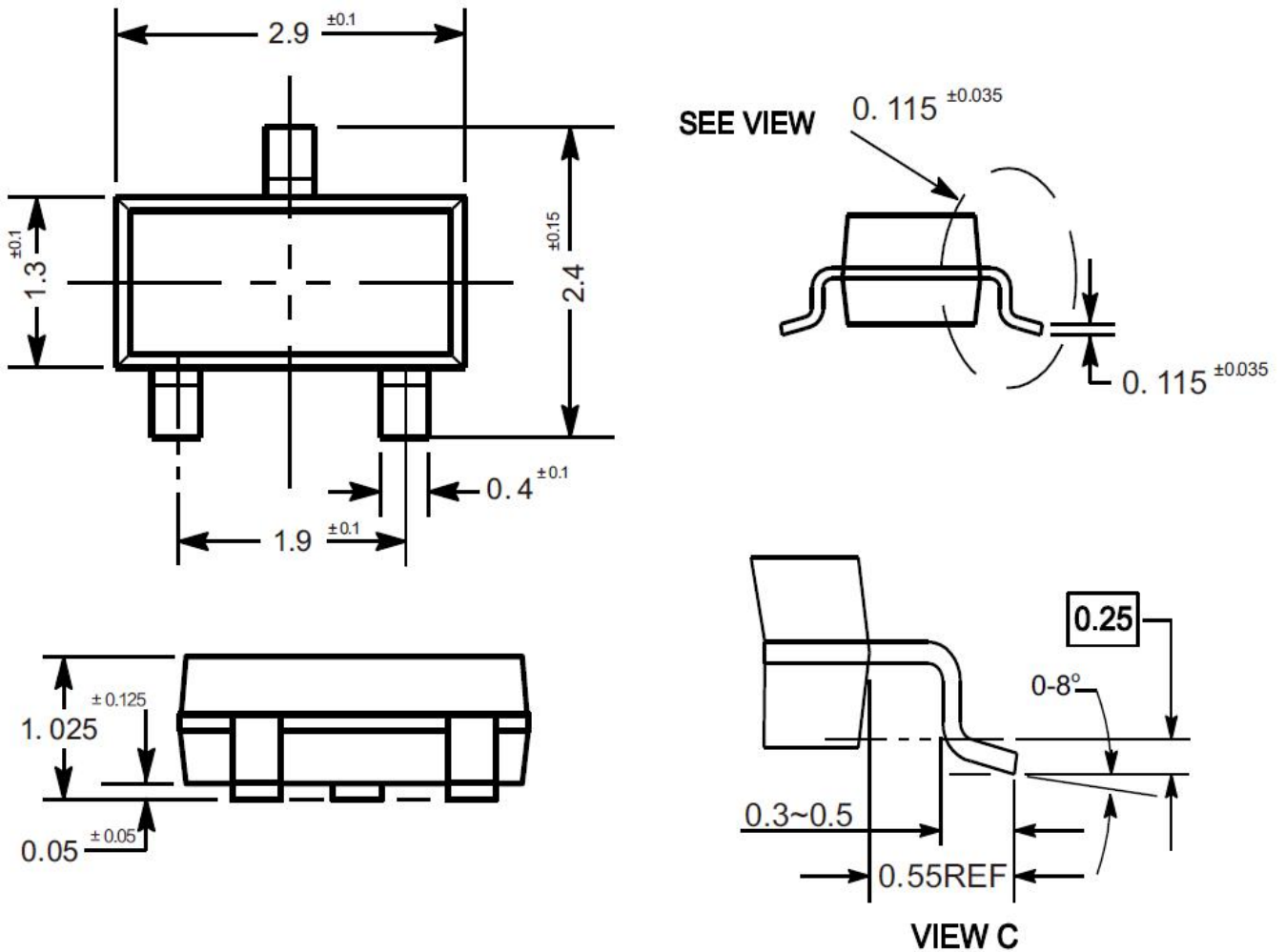

Ordering Information

Device	Package	Shipping
BAV23 Series	SOT-23	3,000PCS/Reel&7inches